

IOM manual

tapflo®

CTS Self-priming Centrifugal Pumps

edition 2016 rev 2



Read this instruction manual carefully,
before you install and operate the pump



CTS I

With 2900 rpm motor:

CTS I CC-22
CTS I CE-22
CTS I DD-40
CTS I DF-40
CTS I EF-55
CTS I EG-55
CTS I EF-75
CTS I EG-75

CTS H

With 2900 rpm motor:

CTS H CC-22
CTS H CE-22
CTS H DD-40
CTS H DF-40
CTS H EF-55
CTS H EG-55
CTS H EF-75
CTS H EG-75



» All about your flow

www.tapflo.com

CONTENTS

0.	GENERAL	5
0.1.	Introduction	5
0.2.	Warning symbols	5
0.3.	Qualification and training of personnel	5
1.	INSTALLATION	6
1.1.	Operation principle	6
1.2.	Receiving inspection	6
1.3.	Storage	6
1.4.	Foundation	6
1.5.	Environment	7
1.6.	Suction and discharge piping	7
1.6.1.	Connection of discharge pipe	7
1.6.2.	Connection of suction pipe	7
1.7.	Health and safety	8
1.7.1.	Protection	8
1.7.2.	Electrical safety	8
1.7.3.	Chemical hazard	8
1.7.4.	Dry running	8
1.7.5.	Noise level	8
1.7.6.	Temperature hazards	8
1.7.7.	Rotating parts	8
1.7.8.	Cleaning and disinfection	9
1.8.	Example of installation	9
1.9.	Instruments	10
1.9.1.	Electric power	10
1.9.2.	Optional instruments	10
1.9.3.	Thermometer	10
1.10.	Motor connection	10
2.	OPERATION	12
2.1.	Start-up	12
2.1.1.	Starting the pump	12
2.1.2.	Restarting after power shut-off	13
2.2.	Stopping the pump	13
2.3.	Cleaning and disinfection	13
2.3.1.	Cleaning procedure	13

CONTENTS

3. MAINTENANCE	14
3.1. Inspections	14
3.2. Location of faults	15
3.3. Disassembly of the pump	16
3.3.1. Disassembly procedure	16
3.4. Assembly of the pump	17
3.4.1. Test run	19
4. SPARE PARTS	20
4.1. Spare parts drawing	20
4.2. Spare parts list	20
4.3. Recommended spare parts	21
4.4. How to order parts	21
5. DATA	22
5.1. Pump code	22
5.2. Dimensions	23
5.3. Materials, data and limits	24
5.4. Mounting torques and dimensions of screws/nuts	24
5.5. Performance curves	25
6. WARRANTY	27
6.1. Returning parts	27
6.2. Warranty	27
6.3. Warranty form	29

CE CERTIFICATE



EC declaration of conformity

Tapflo AB hereby declares with full liability that all centrifugal pumps identified as:

CTH...; CTI...; CTM...; CTV...; CTS...

to which the following declaration relates to, comply with the requirements of the following guidelines and harmonized standards:

EN 809:1998+A1:2009
EN 809:1998+A1:2009/AC:2010
EN 12162:2001+A1:2009
EN ISO 20361:2009
EN 60034-1:2011
EN 60034-30:2009

and comply with the essential requirements of:

Directive 2006/42/EC of the European Parliament and of the Council of 17 May 2006 on machinery, and amending Directive 95/16/EC;

Directive 2006/95/EC of the European Parliament and of the Council of 12 December 2006 on the harmonization of the laws of Member States relating to electrical equipment designed for use within certain voltage limits;

Directive 2005/32/EC of the European Parliament and of the Council of 6 July 2005 establishing a framework for the setting of eco-design requirements for energy-using products and amending Council Directive 92/42/EEC and Directives 96/57/EC and 2000/55/EC of the European Parliament and of the Council.

The centrifugal pump, to which the following declaration relates to, can be put into operation only if they have been installed according to the manufacturers recommendations and if the installation to which they have been connected to complies with the requirements of the 2006/42/EC directive.

Manufacture by Tapflo Spzoo, Poland for:

Tapflo AB
Filaregatan 4
4434 Kungälv, Sweden

Year of CE marking:
CTV – CE08
CTM – CE09
CTI/CTH – CE10
CTS – CE14

Tapflo AB, June 2nd, 2014

Håkan Ekstrand
Managing director

0. GENERAL

0. GENERAL

0.1. Introduction

CTS is an open impeller self-priming centrifugal pump, manufactured from stainless steel AISI 316L. CTS H with excellent electro polished surfaces, FDA approved seals, high finish and mechanical strength, meet the demands from food and sanitary applications, CTS I with AISI 316L chemical resistance and mechanical strength is a reliable choice.

The self-priming feature allows to use the pump in applications where standard CT pumps do not prove useful. The CTS pump is capable of creating up to 4,5 m of suction lift.

With proper attention to maintenance, CTS pumps will give efficient and trouble free operation. This instruction manual will familiarise operators with detailed information about installing, operating and maintaining the pump.

0.2. Warning symbols

The following warning symbols are present in this instruction manual. This is what they say:



This symbol stands next to all safety instructions in this instruction manual where danger to life and limb may occur. Observe these instructions and proceed with utmost caution in these situations. Inform also other users of all safety instructions. In addition to the instructions in this instruction manual, the general safety and accident prevention regulations must be observed.



This signal stands at points in this instruction manual of particular importance for compliance with regulations and directives, for correct work flow and for the prevention of damage to and destruction of the complete dampener or its subassemblies.



This symbol signals possible danger caused by the presence of electric fields or live wires.

0.3. Qualification and training of personnel



The personnel in charge of installation, operation and maintenance of the pumps we produce must be qualified to carry out the operations described in this manual. Tapflo shall not be held responsible for the training level of personnel and for the fact that they are not fully aware of the contents of this manual.

1. INSTALLATION

1. INSTALLATION

1.1. Operation principle

In order for the priming action to be achieved, the pump casing has to be filled with liquid to a level above the impeller (1). When the pump starts its operation, it is slowly sucking out the air from the suction line thus creating negative pressure and lifting the product. The air is mixed with the liquid in the pump casing (2). In order to achieve the self-priming capability, the shut-off / regulation valve on the discharge side must be opened. The air escapes the casing through the discharge line while the liquid returns to the impeller as it has higher specific gravity than the liquid/air mixture. This process continues until the suction line is completely free of air and the pump can operate as a standard centrifugal pump (3).

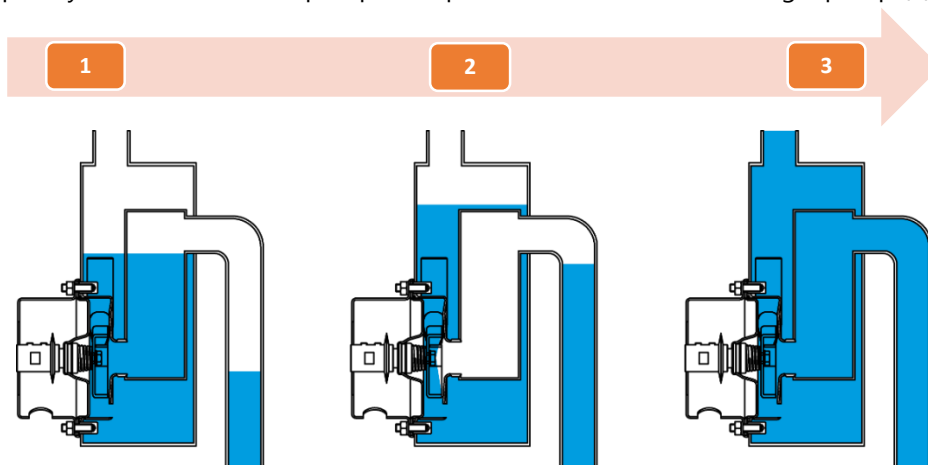

1.2. Receiving inspection

Although precaution is taken by us when packing and shipping, we urge you to carefully check the shipment on receipt. Make sure that all parts and accessories listed on the packing list are accounted for. Immediately report any damage or shortage to the transport company and to us.

1.3. Storage



If the equipment is to be stored prior to installation, place it in a clean location. Do not remove the protective covers from the suction and discharge which have been fastened to keep pump internals free of debris. Clean the pump thoroughly before installation. When in storage, turn the shaft by hand at least twice per week.

1.4. Foundation



The pump-motor unit must stand on and be fixed to a sufficiently rigid structure that can support the entire perimeter on which the unit stands. The foundation on a firm bottom is the most satisfactory. Once the pump is in position, adjust level with metal shims between the feet and the surface on which it stands. Check that the feet of the pump motor unit stand well on each of them. The surface on which the foundation stands must be flat and horizontal. If the unit is fitted on a steel structure, make sure that it is supported so that the feet do not warp. In any case, it is advisable to fit some anti-vibration rubber pieces between

1. INSTALLATION

the pump and the brickwork. The motor needs an additional stand as its level is higher than that of the pump casing. As an option the pump can be ordered with feet for the motor. For close-coupled type, pump motor alignment is not required.

1.5. Environment



- There should be enough space in the vicinity of the pump in order to operate, maintain and repair it.
- The area in which the pump is operated, must be sufficiently ventilated. Excessive temperature, humidity or dirt may affect the pump operation'/'
- Behind the cooling fan of the motor there must be sufficient room for the hot air to escape the motor.

1.6. Suction and discharge piping



A pump is generally part of a piping system that can include a number of components such as valves, fittings, filters, expansion joints, instruments, etc. The way the piping is arranged and the positioning of the components has a great influence on the operation and the lifetime of the pump. The pump cannot be used as a support for the components connected to it.

The flow of liquid from the pump must be as even as possible. It is advisable to avoid any tight bends or drastic reductions of diameters that may cause flow resistance in the installation. In case of diameter reduction, it is advisable to use appropriate conical reductions (possibly eccentric on suction side and concentric on discharge side) at changes of diameter and at a minimum distance from pump connections of five diameters.

NOTE! The pump casing is designed for maximal work pressure of 3 bar (for CTS C) and 4,5 bar (for CTS D,E), therefore exceeding these limits is prohibited.

1.6.1. Connection of discharge pipe



A shut-off / regulation valve is normally fitted on the discharge side. It cuts off the pump from the line and adjusts the output. Never adjust flow rate using the valve on the suction pipe.

NOTE! When starting the pump, the valve on the discharge side must be opened to allow the pump to self-prime.

1.6.2. Connection of suction pipe



The suction piping is very important for the correct operation of the pump assembly. It must be as short and as direct as possible. If a longer suction line is unavoidable, the diameter should be large enough, i.e. at least as the inlet connection on the pump, to ensure less flow resistance. In any case, suction must be carried out properly avoiding any air locks.

It is recommended to use check valve in the suction line to avoid siphoning when the pump stops. A foot valve on the suction side can prove useful when suction height is big. It allows to shorten the time of pump self-priming.

1. INSTALLATION

1.7. Health and safety

The pump must be installed according to local and national safety rules.



The pumps are constructed for particular applications. Do not use the pump on applications different from that for which it was sold without consulting us to ascertain its suitability.

1.7.1. Protection



In the interest of health and safety it is essential to wear protective clothing and safety goggles when operating, and/or working in the vicinity of Tapflo pumps.

1.7.2. Electrical safety



Do not carry out any maintenance or/and operation on the pump while it is running or before it has been disconnected from the power supply. Avoid any danger caused by electric power (for details see current regulations in force). Check that electrical specifications on the data plate are equivalent to the power supply to which it will be connected.

1.7.3. Chemical hazard



Whenever the pump is to be used for pumping a different liquid, it is essential to clean the pump beforehand in order to avoid any possible reaction between the two products.

1.7.4. Dry running



Do not start nor carry out running tests before filling the pump with liquid. Always avoid dry operation of the pump. Start the pump when it is completely filled and with the valve on the discharge side opened.

1.7.5. Noise level



CT pumps, including the motor, in normal operating conditions produce a sound level below 80 dB(A). The major sources of noise are: liquid turbulence in the installation, cavitation or any other abnormal operation that is independent from the pump construction nor the pump manufacturer. The user must provide suitable protective means if the sources of noise could produce a harmful noise level for operators and for the environment (in compliance with current local regulations).

1.7.6. Temperature hazards



Raised temperature can cause damage on the pump and/or piping and may also be hazardous for personnel in the vicinity of the pump/piping. The hot or cold parts of the machine must be protected to avoid accidental contacts

1.7.7. Rotating parts



Do not tamper with the protection of the rotating parts, do not touch or approach rotating parts in movement.

1. INSTALLATION

1.7.8. Cleaning and disinfection



Cleaning and disinfection of the pump system is of greatest importance when the pump is used in a food process installation. Use of a pump system that is NOT cleaned or disinfected can cause contamination of the product.

1.8. Example of installation

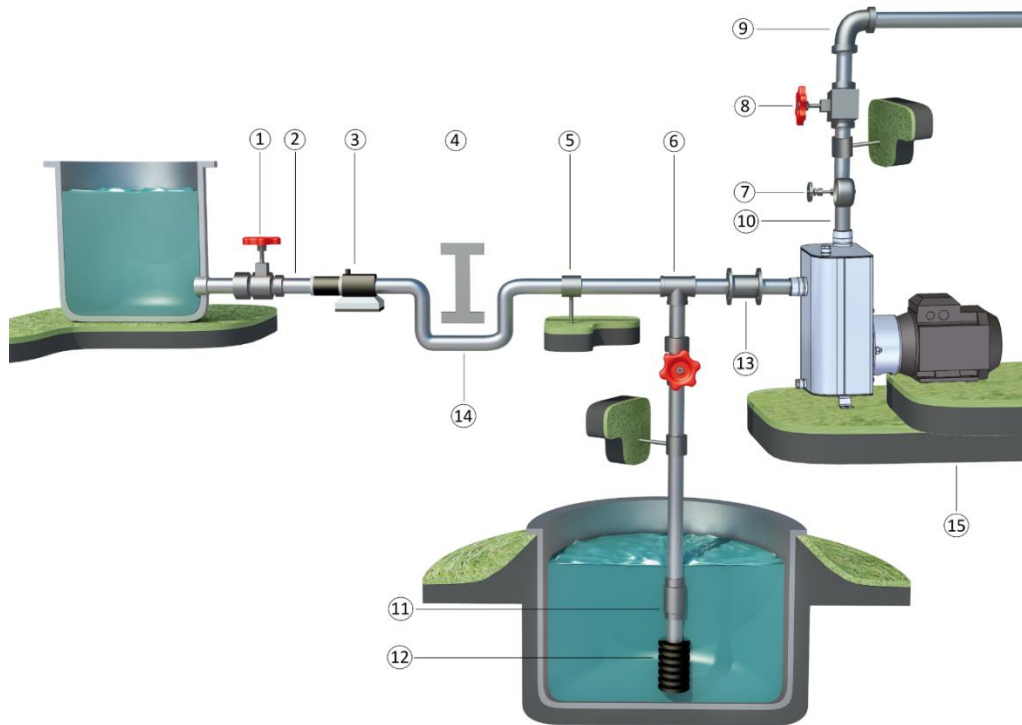

- 1) YES: Gate valve (may also be near pump in case of long piping)
- 2) With positive head: tilt of piping towards pump
- 3) YES: line strainer if particles are present
- 4) NO: air pockets – the circuit must be short and straight
- 5) YES: pipe fastening
- 6) Suction line as short and direct as possible
- 7) YES: attachment for gauge or safety pressure switch
- 8) YES: adjusting gate valve on outlet
- 9) Bends placed after valves and instruments not closer to the pump inlet than five times the piping diameter
- 10) NO: elbow joints (and other bends) on the pump inlet and outlet
- 11) OPTIONAL: check valve
- 12) YES: strainer if particles are present
- 13) YES: expansion joint (necessary with long pipes or hot liquids) and/or anti-vibration facility during discharge and suction – anchored near the pump
- 14) YES: overcoming obstacles at lower depths
- 15) Fix the pump to the stand by means of holes in the motor feet. The stand must be level

1. INSTALLATION

1.9. Instruments



In order to ensure a proper control of the performance and the conditions of the installed pump, we recommend using the following instruments:

- a pressure-vacuum gauge on the suction piping;
- a pressure gauge on the discharge piping.

The pressure intakes must be made of straight pieces of piping at a distance of minimum five diameters from the pump inlets. The pressure gauge on discharge must always be fitted between the pump and the shut-off / regulation valve. The output can be read on the pressure gauge, transformed into meters and then compared with the typical curves.

1.9.1. Electric power

The electric power absorbed by the motor can be measured by means of a wattmeter.

1.9.2. Optional instruments

The optional instruments can indicate if pump is working in an abnormal way. The abnormal conditions can be caused by: accidentally closed valves, lack of pumped liquid, overloads, etc.

1.9.3. Thermometer

If the temperature of the pumped liquid is a critical parameter, provide the installation with a thermometer (preferably on the suction side).

1.10. Motor connection



An expert electrician must always carry out the electrical connection. Compare the power supply with the data plate specifications and then choose a suitable connection. The type of connection is stated on the motor data plate and can be Y (star) or D (Delta), according to the power supply of the motor (see figure below).

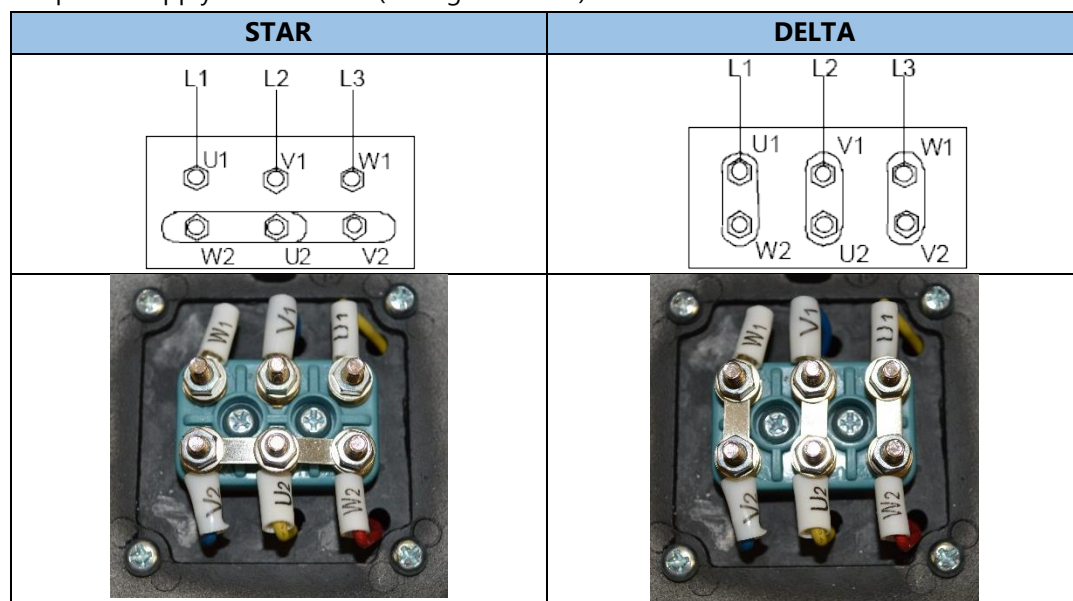

1. INSTALLATION

Follow the connection standard used in the plant. In no case connect the electrical motor directly to supply network but use a suitable electric switchboard equipped with a knife switch and suitable safety devices (e.g. motor breaker switches) in the power circuit. Safety devices against overloads must also protect the motors. Make sure that the motor has suitable grounding and that it has been connected properly.

2. OPERATION

2. OPERATION

2.1. Start-up

- Check manually that the motor is free to turn, moving the motor cooling fan.
- Make sure that the piping is not clogged and is free from residues or foreign objects. Make sure that the liquid flows regularly into the pump.



- The pump casing must be filled with liquid. The minimum water level is:
 - 240 mm \pm 5 (9,5 \pm 0,2 inch) or 7 dm³ (1,54 UK gal) for CTS C pumps
 - 300 mm \pm 5 (11,8 \pm 0,2 inch) or 11,8 dm³ (2,6 UK gal) for CTS D, E pumps

- The suction shut-off valve (if any) must be completely open.



- The shut-off / regulation valve on the discharge side must be opened.

- The motor must turn in the same direction as the arrow shown on the pump. The direction of rotation is always clockwise looking at the pump from the motor side; check by starting briefly, then looking at the direction of rotation of the motor fan through the fan lid. If it is wrong, the motor must be stopped immediately. Change the connection to the terminals of the electric motor (chapter 1.8 "Motor connection") and repeat the procedure described above.



- Any auxiliary connections must all be connected.
- When restarting the pump, make sure to drain the discharge line. It is important that during self-priming there is no back pressure, so the air can easily escape the pump casing.
- If the pump is equipped with an oil reservoir, make sure to fill it before start-up.

2.1.1. Starting the pump



Start the electric motor. **The discharge shut-off / regulation valve must be completely opened.**

If the pressure shown on the pressure gauge on the discharge piping does not increase, turn off the pump immediately and release pressure carefully. Repeat the connection procedure.

If there are changes of flow rate, head, density, temperature or viscosity of the liquid, stop the pump and get in touch with our technical service.

2. OPERATION

2.1.2. Restarting after power shut-off



In case of accidental stopping, make sure that the non-return valve has prevented backflow and check that the motor cooling fan has stopped. Start the pump again following the instructions of chapter 2.1.1 "Starting the pump".

2.2. Stopping the pump



It is advisable to close the discharge shut-off / regulation valve gradually and stop the motor immediately after. The reverse sequence is not recommendable, especially with larger pumps or longer delivery piping. That is to avoid any problems due to water hammering. If a suction shutoff valve has been installed, it is advisable to close it completely.

2.3. Cleaning and disinfection



Cleaning and disinfection of the pump system is of greatest importance when the pump is used in a food processing installation. Use of a pump system that is NOT cleaned or disinfected can cause contamination of the product. The cleaning cycles as well as chemicals to use for the cleaning vary depending on the pumped product and the process. The user is responsible to establish a suitable cleaning and / or disinfection program according to local and public health and safety regulations.

2.3.1. Cleaning procedure

The pump may be cleaned in two different ways:

CIP (Cleaning In Place)

without dismantling the pump, using steam, water or cleaning chemicals. Follow these safety instructions during the CIP procedure:



- Make sure that all cleaning line connections are properly tightened to avoid splashing of hot water or cleaning chemicals.
- When using an automatic process, a safety device should be installed to avoid unintentional automatic start-up of the pump.
- Before any disassembly of the pump, fittings or pipes, make sure that the cleaning cycle is finished.

Manual cleaning

by simply dismantling the pump casing, impeller and mechanical seal. Always follow these safety instructions:



- Switch off the electric power to the motor and disconnect the motor starting system if installed.
- The cleaning personnel shall wear suitable protective clothing, footwear and goggles.
- Use a suitable non-toxic and non-flammable cleaning solution.
- Always keep the area around the pump clean and dry.
- Never clean the pump by hand with pump running.

3. MAINTENANCE

3. MAINTENANCE



Maintenance work on electrical installations must be performed by qualified personnel and only when the power supply has been shutoff. Follow the local and national safety regulations.

3.1. Inspections

- Periodically check suction and discharge pressures.
- Inspect the motor according to the instructions from the motor manufacturer.
- In general, a mechanical seal does not require maintenance, but the pump should never run when empty (dry). If a leakage occurs, replace the mechanical seal.

3. MAINTENANCE

3.2. Location of faults

	Overheating of motor										Possible reason	Solution	
	Insufficient flow rate or pressure in pump	No pressure on the discharge side	Irregular discharge flow / pressure	Noise and vibrations	The pump gets clogged	Overheating of the pump	Abnormal wear	Leak in mechanical seal	The pump does not prime				
	X		X								X	Wrong direction of rotation	Invert the direction of rotation
	X	X	X	X							X	Insufficient suction head (NPSH)	Increase available NPSH: <ul style="list-style-type: none"> ➢ Raise the suction reservoir ➢ Lower the pump ➢ Reduce the vapour pressure ➢ Increase the diameter of the suction pipe ➢ Make suction pipe short and direct
			X									Pump is clogged	Clean the pump
	X		X	X			X					Cavitation	Increase suction pressure
	X		X	X			X				X	The pump sucks air	Make sure all connections are tight
			X	X	X						X	Suction pipe is blocked	Check pipes / valves and filters on the suction line
	X			X								Discharge pressure too high	Reduce the head by increasing pipe diameter and/or reduce number of valves and bends
X				X	X		X					Flow rate too high	Reduce the flow: <ul style="list-style-type: none"> ➢ Partially close the discharge valve ➢ Reduce the impeller diameter (contact us) ➢ Reduce the rotation speed
	X			X	X	X	X					Liquid temperature too high	Cool the liquid
								X				Broken or worn mechanical seal	Replace the seal
								X				Wrong material of O-rings for the liquid	Mount O-rings in other material (contact us)
X				X	X	X						The impeller scratches	Reduce the temperature and / or suction pressure. Adjust clearance between housing and impeller
				X			X					Loads on the pipes	Connect the pipes independent of the pump
				X	X	X	X					Foreign objects in the liquid	Use a filter on the suction side
								X				Spring tension too low on mechanical seal	Adjust as mentioned in this manual
		X									X	Shut-off valve closed on suction side	Check and open the valve
	X											Discharge pressure too low	Increase the pressure – install an impeller with a bigger diameter (contact us)
					X	X					X	Pump is not filled with liquid	Fill pump with liquid
X	X			X								Liquid parameters different than calculated	Check pumped liquid parameters

3. MAINTENANCE

3.3. Disassembly of the pump



The disassembly should only be performed by qualified personnel.



Each operation carried out on the machine must always be carried out once all the electrical contacts have been disconnected. The pump-motor unit must be placed in a position where it cannot be started unintentionally.



Before servicing in any way the parts that come in contact with the pumped liquid, make sure that the pump has been fully emptied and washed. When draining the liquid, make sure that there is no danger for people or the environment.

The numbers put in brackets, refer to the part numbers in the spare part drawings and spare part lists in chapter 4 "Spare parts".

3.3.1. Disassembly procedure



Fig. 3.3.1

Unscrew the casing mounting nuts [143] and remove the washers [142].
Take off the pump casing [131S].



Fig. 3.3.2

Remove the O-ring [18].
NOTE! After every disassembly the O-ring [18] has to be replaced by a new one.



Fig. 3.3.3

Remove the impeller mounting screw [191] and the washer [192], use a spanner key in the opening of the pump back cover [11] to hold the shaft [16] to lock the impeller. Remove the impeller.



Fig 3.3.4

Carefully remove the back casing [12]. The static part [15B] of the mechanical seal will remain in the back casing.

3. MAINTENANCE



Fig 3.3.5

If necessary, push out the static part [15B] of the mechanical seal.

NOTE! Apply some alcohol or water before pushing out of the mechanical seal.



Fig 3.3.6

Remove the deflector [17].

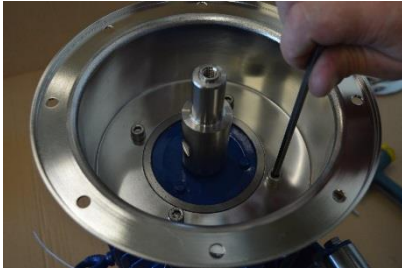

Fig 3.3.7

Remove the screws [121] and washers [122] holding the back cover [11] to the motor [10].

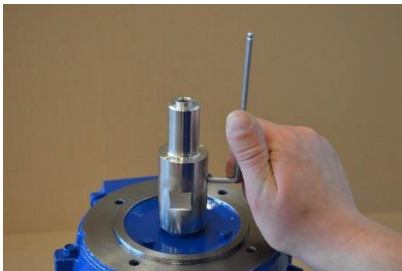

Fig 3.3.8

Loosen the lock screws [161] and remove the shaft extension [16].

The pump is now completely disassembled. Check all components, especially the casing O-ring and mechanical seal, for wear or damage and replace if necessary.

3.4. Assembly of the pump

The assembly procedure is done in the reverse order to the disassembly.

Nevertheless there are a few things that you have to remember in order to assemble the pump correctly.



Fig. 3.4.1

When mounting the impeller [9...] on the shaft extension [16] make sure that it is locked in the proper position before tightening the mounting screw [191] with its washer [192].

NOTE! Take care not to damage the head surface of the shaft extension.

3. MAINTENANCE



Fig. 3.4.2

Before assembly of the mechanical seal [15] wet the O-rings with alcohol.



Fig. 3.4.3

After inserting the static part [15B] of the mechanical seal, fit the back casing [12] onto the back cover [11] and check the seal fitting dimension according to the table below. This ensures that correct pressure is applied on the mechanical seal by the impeller.

NOTE! This is a very important procedure when you have taken off the shaft extension.



Fig. 3.4.4

Using a calliper, adjust the "S" dimension. It is achievable by loosening the lock screws [161] and moving the shaft extension [16] up or down.

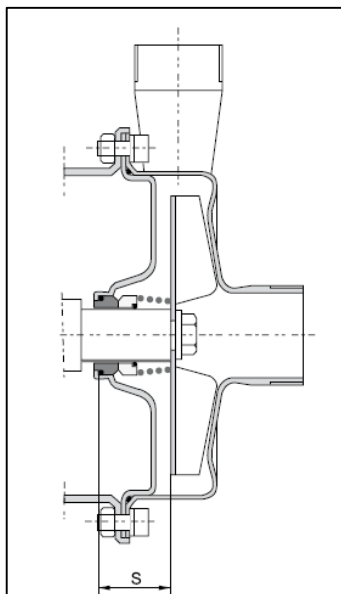

Pump type	S [mm]
CTS C	35.5
CTS D	35.5
CTS E	35.5



Fig. 3.4.5

When assembling the casing, make sure that the O-ring sealing surfaces on the casing [131S] and the back casing [12] are clean.

3. MAINTENANCE



Fig. 3.4.6

To screw in the casing pin screws [141S] use two nuts tightened against each other.

3.4.1. Test run



We recommend you to conduct a test run of the pump before installing it in the system, so no liquid gets wasted if the pump leaks or perhaps does not start accordingly to wrong assembly of the pump.

After a few weeks of operation retighten the screws with appropriate torque.

4. SPARE PARTS

4. SPARE PARTS

4.1. Spare parts drawing

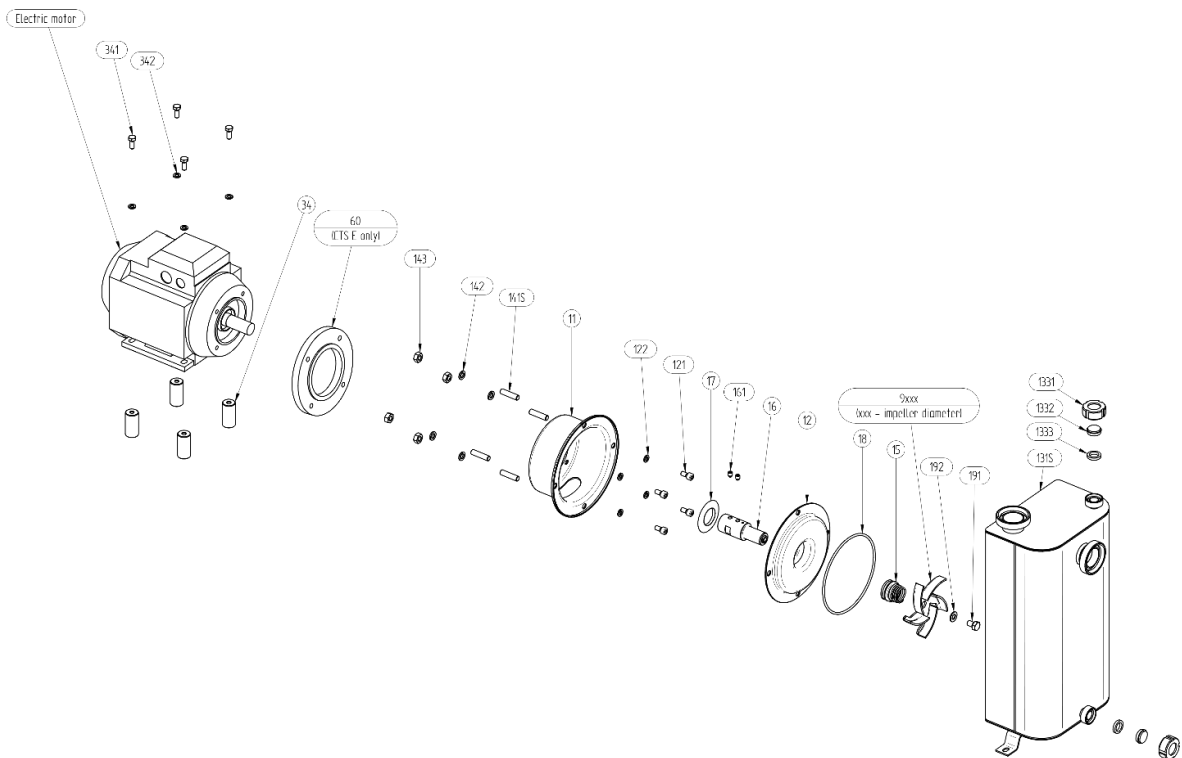

4.2. Spare parts list

Pos.	Description	Size			Material	
		CTS C	CTS D	CTS E	CTS I	CTS H
-	Electric motor	1	1	1		
11	Back cover [H/N]*	1	1	1	AISI 316L Glass blasted	AISI 316L Ra<0.8
12	Back casing [H/N]	1	1	1	AISI 316L	AISI 316L Ra<0.8
121	Back cover mounting screws	4	4	4	AISI 316L	AISI 316L
122	Back cover mounting washers	4	4	4	AISI 316L	AISI 316L
131S	Pump casing [H/N]	1	1	1	AISI 316L Glass blasted	AISI 316L Ra<0.8
1331	Drain plug screw cap	2	2	2	AISI 316L	AISI 316L
1332	Drain plug stopper	2	2	2	AISI 316L	AISI 316L
1333	Drain plug O-ring	2	2	2		
141S	Casing mounting screws	4	8	8	AISI 316L	AISI 316L
142	Casing mounting washers	4	8	8	AISI 316L	AISI 316L
143	Casing mounting nuts	4	8	8	AISI 316L	AISI 316L
15	Mechanical seal (complete) [H/N]	1	1	1	See 5.1	See 5.1
16	Shaft extension	1	1	1	AISI 316L	AISI 316L
161	Lock screw	1	2	2	AISI 316	AISI 316
17	Deflector	1	1	1	NBR	NBR
18	Casing O-ring [H/N]	1	1	1	EPDM (std), FKM, FEP/Silicone, NBR	EPDM FDA (std), FKM, FEP/Silicone FDA
191	Impeller mounting screw	1	1	1	AISI 316L	AISI 316L
192	Impeller mounting washer	1	1	1	AISI 316L	AISI 316L
34	Feet	4	4	4	AISI 316L	AISI 316L
341	Feet mounting screws	4	4	4	AISI 316L	AISI 316L
342	Feet mounting washers	4	4	4	AISI 316L	AISI 316L
60	Motor adaptive flange	-	-	1	Aluminium	Aluminium
9...	Impeller	1	1	1	AISI 316L Glass blasted	AISI 316L Ra<0.8



Parts indicated as [H/N] have different execution for CTS I and CTS H pumps. When ordering spare parts please indicate if the part is for Industrial or Hygienic series e.g. 5-340N-11 or 5-340H-11.

4. SPARE PARTS

4.3. Recommended spare parts

Normally the CTS pump is maintenance free. However, depending on the nature of the liquid and temperature etc., some parts of the pump are subject to wear and have to be replaced. We recommend having the following parts in stock:

Pos.	Description	Q-ty
15	Mechanical seal	1
18	Casing O-ring	1

4.4. How to order parts

When ordering spare parts for Tapflo pumps, please let us know what is the **model number** and **serial number** from the pump's name plate. Then just indicate the part numbers from the spare parts list and quantity of each item.

5. DATA

5. DATA

5.1. Pump code

The model number on the pump and on the front page of this instruction manual tells the pump size and materials of the pump.

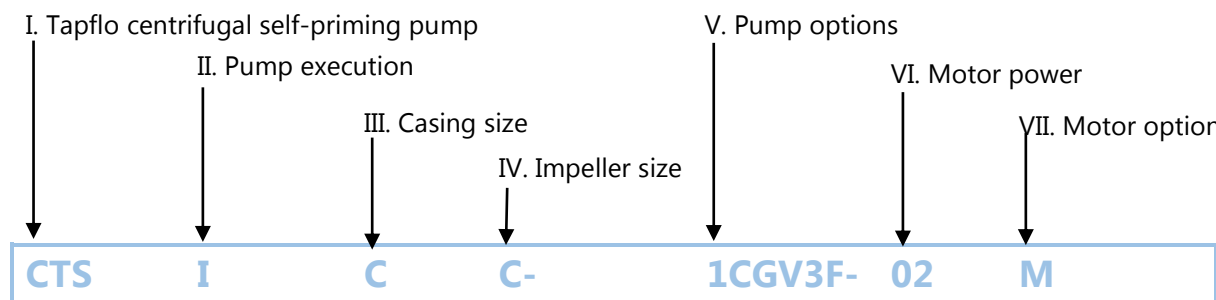

I. CTS = Tapflo centrifugal self-priming pump

II. Pump execution:

I = Industrial H = Hygenic

III. Casing size (motor flange diameter / IEC size):

C = 140 mm / 90
D = 160 mm / 100 or 112
E = 200 mm / 132

IV. Impeller size

C = 125 mm F = 155 mm
D = 130 mm G = 180 mm
E = 135 mm

V. Pump options:

1. Mechanical seal:

Blank* = ceramin/graphite/EPDM (FDA on CTS H)
1CGV = ceramin/graphite/FKM (FDA on CTS H)
1CGF = ceramin/graphite/FEP (FDA)
1CGN = ceramin/graphite/NBR (CTS I only)
1SSE = SiC/SiC/EPDM (FDA on CTS H)
1SSV = SiC/SiC/FKM (FDA on CTS H)
1SSF = SiC/SiC/FEP (FDA)
1SSN = SiC/SiC/NBR (CTS I only)
1SGE = SiC/graphite/EPDM (FDA on CTS H)
1SGV = SiC/graphite/FKM (FDA on CTS H)
1SGF = SiC/graphite/FEP (FDA)
1SGN = SiC/graphite/NBR (CTS I only)

3. Connection options

Blank* = Thread BSP on CTS I
 Thread DIN 11851 on CTS H

3B = BSPT thread (on CTS H)

3C = Clamp ISO 1852 (CTS H only)

3T = Clamp DIN 32676 (CTS H only)

3S = Thread SMS (CTS H only)

3R = Thread RJT (CTS H only)

3P = ISO 1127 clamp (CTS H only)

DA = DIN11866-1A thread (CTS H)

4. Special executions

4Z = Oil lubricated seal

4H = Semi open heavy duty impeller

PX = Welds polishing (CTH S only)

W = Reinforced impeller (D and F sizes only)

Q = Extra quench

VI. Motor power / IEC motor size

2900 rpm motors (2-pole):

22 = 2.2 kW / 90

40 = 4.0 kW / 112

55 = 5.5 kW / 132

75 = 7.5 kW / 132

VII. Motor options

M = Hygenic motor shroud (CTS H)

X2d = Eex d IIB T4 motor

X2e = Eex e IIB T3 motor

X2de = Eex de IIB T4 motor

X2nA = Eex nA IIB T4 motor

X3e = Ex II 3G T135C motor - tropic

T = Motor with PTC thermistor

F60 = 60 Hz motor

* = standard execution

5. DATA

5.2. Dimensions

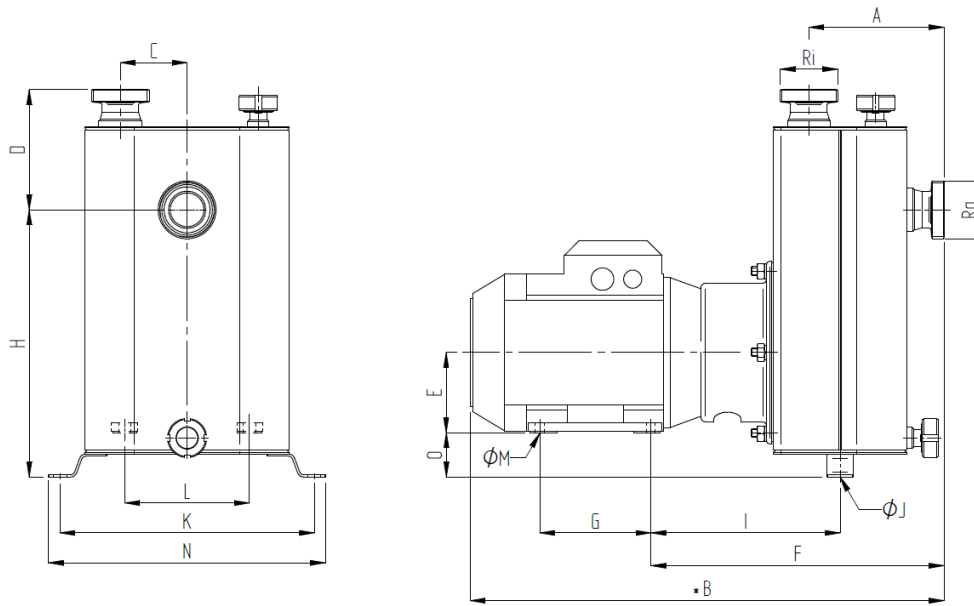

Dimensions in mm (where other is not indicated)

Dimensions in inch (where other is not indicated)

General dimensions only, ask us for detailed drawings. Changes reserved without notice.

MODEL	CTS CC-22	CTS CE-22	CTS DD-40	CTS DF-40	CTS EF-55	CTS EG-55	CTS EF-75	CTS EG-75
Motor power	2.2	2.2	4.0	4.0	5.5	5.5	7.5	7.5
IEC motor size	90	90	112	112	132	132	132	132
Weight [kg]	35.5	35.5	56	56	63	63	78	78
A	152 6	152 6	170 6.7	170 6.7	170 6.7	170 6.7	170 6.7	170 6.7
*B	532.5 21	532.5 21	641 25.2	641 25.2	692 27.2	692 27.2	692 27.2	692 27.2
C	75 3	75 3	90 3.5	90 3.5	90 3.5	90 3.5	90 3.5	90 3.5
D	135 5.3	135 5.3	120 4.7	120 4.7	120 4.7	120 4.7	120 4.7	120 4.7
E	90 3.5	90 3.5	112 4.4	112 4.4	132 5.2	132 5.2	132 5.2	132 5.2
F	329.5 13	329.5 13	378 14.9	378 14.9	414 16.3	414 16.3	414 16.3	414 16.3
G	125 4.9	125 4.9	140 5.5	140 5.5	178 7	178 7	178 7	178 7
H	300.5 11.8	300.5 11.8	377 14.8	377 14.8	377 14.8	377 14.8	377 14.8	377 14.8
I	212.5 8.4	212.5 8.4	243 9.6	243 9.6	279 11	279 11	279 11	279 11
ØJ	9 0.4	9 0.4	9 0.4	9 0.4	9 0.4	9 0.4	9 0.4	9 0.4
K	286 11.3	286 11.3	336 13.2	336 13.2	336 13.2	336 13.2	336 13.2	336 13.2
L	140 5.5	140 5.5	190 7.5	190 7.5	216 8.5	216 8.5	216 8.5	216 8.5
ØM	10 0.4	10 0.4	12 0.5	12 0.5	12 0.5	12 0.5	12 0.5	12 0.5
N	311 12.2	311 12.2	362 14.3	362 14.3	362 14.3	362 14.3	362 14.3	362 14.3
O	50 2	50 2	55 2.2	55 2.2	35 1.4	35 1.4	35 1.4	35 1.4

*The dimension may vary depending on motor brand

5. DATA



Connection dimensions BSPT (male thread)		
Model	Ra	Ri
CTSI C	1 ½"	1 ½"
CTSI D	2 ½"	2"
CTSI E	2 ½"	2"

Connection dimensions DIN 11851 (male thread)		
Model	Ra	Ri
CTSH C	DN40	DN40
CTSH D	DN65	DN50
CTSH E	DN65	DN50

5.3. Materials, data and limits

	CTSH ...	CTSI ...
Casing	Stainless steel AISI 316L electro polished Ra<0.8	Stainless steel AISI 316L glass blasted
Impeller	Stainless steel AISI 316L electro polished Ra<0.8. open (std) or semi-open	Stainless steel AISI 316L glass blasted. open (std) or semi-open
Mechanical seal	Single ceramic/graphite (std), SiC/SiC or SiC/graphite, optional with oil lube	Single ceramic/graphite (std), SiC/SiC or SiC/graphite, optional with oil lube
O-rings	EPDM FDA approved (std), FEP/Silicone FDA approved, FKM FDA approved	EPDM (std), FKM, FEP/Silicone or NBR
Motor	IP55. IEC frame B34. Available with ATEX cat 2 or 3. Eex e or Eex d	
Pressure rating	PN 2,5 bar (CTS C) at 20°C; PN 4 bar (CTS D,E) at 20°C	
Temperature	Max 90°C	
Viscosity	Max ~200 cSt	
Particles	Max diameter is 6 mm (std open impeller). bigger if soft particles	

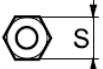
5.4. Mounting torques and dimensions of screws/nuts

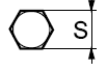
Screw / nut type	Description	Pump model		
		CTS C ...	CTS D ...	CTS E ...
	Pos. 121. allen screw Mounting torque [Nm] Too size "S" [mm] Thread	15 5 M6	15 6 M8	15 6 M8
	Pos. 143. hexagonal nut Mounting torque [Nm] Too size "S" [mm] Thread	15 17 M10	15 13 M8	15 13 M8
	Pos. 161. allen screw Mounting torque [Nm] Too size "S" [mm] Thread	17 4 M8	17 4 M8	17 4 M8
	Pos. 191. hexagonal screw Mounting torque [Nm] Too size "S" [mm] Thread	17 17 M10	17 17 M10	17 17 M10

5. DATA

5.5. Performance curves

The performance curves are based on water at 20°C. Speed 2900 rpm.

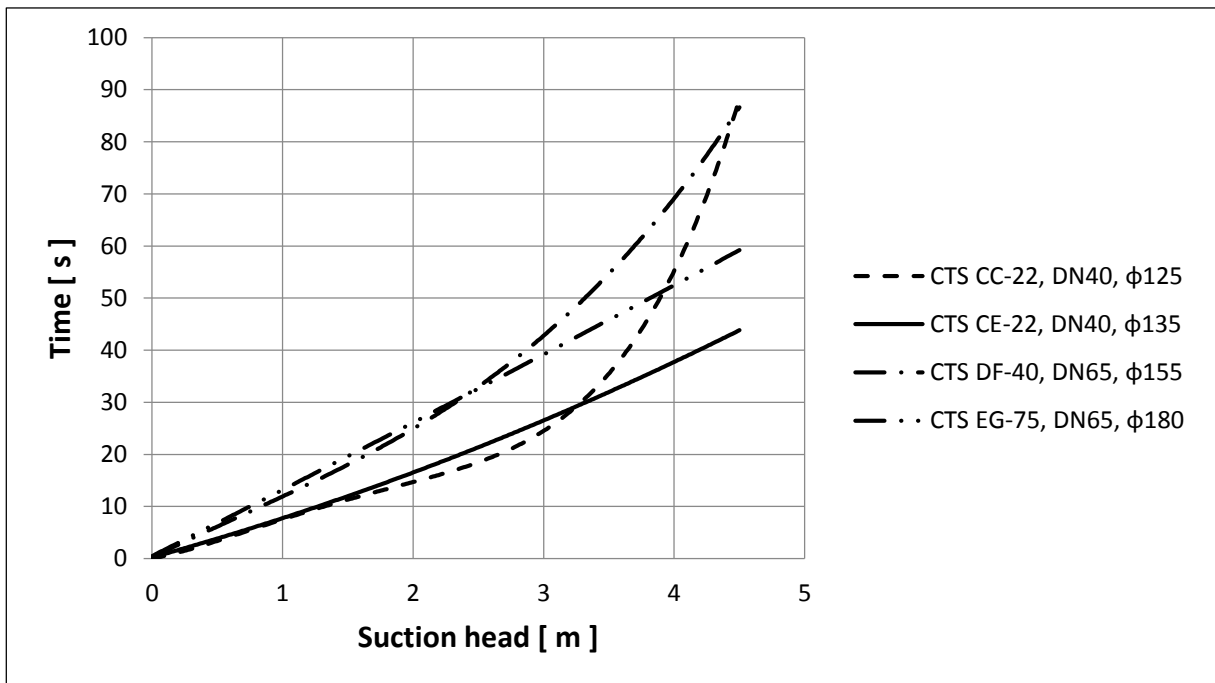
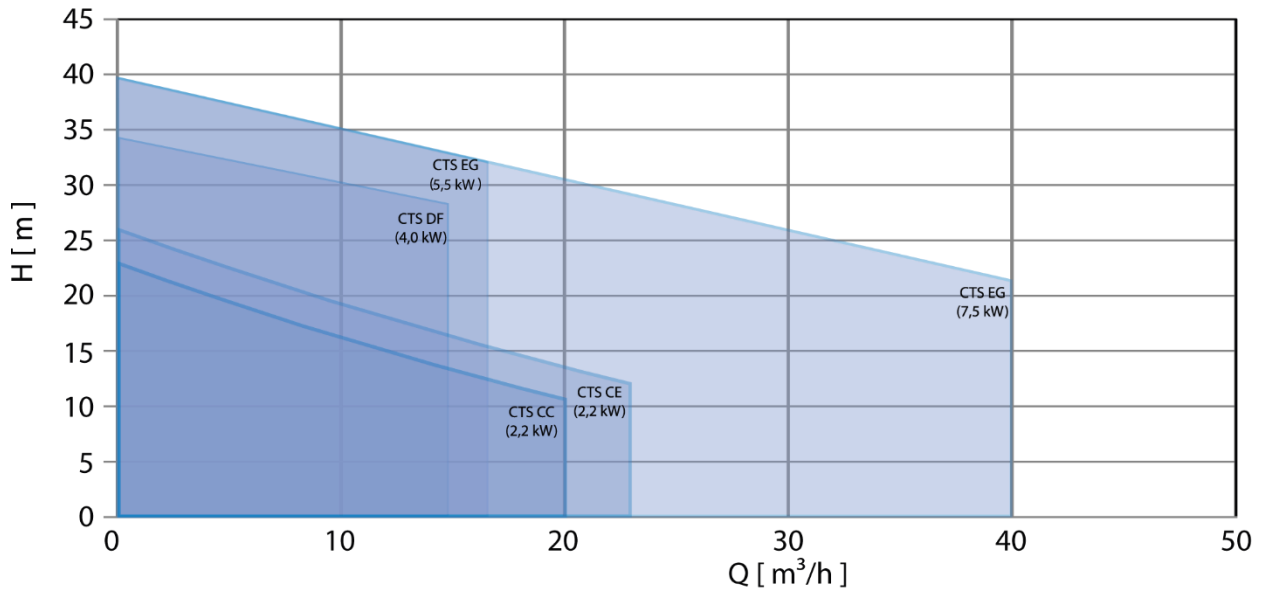

5. DATA

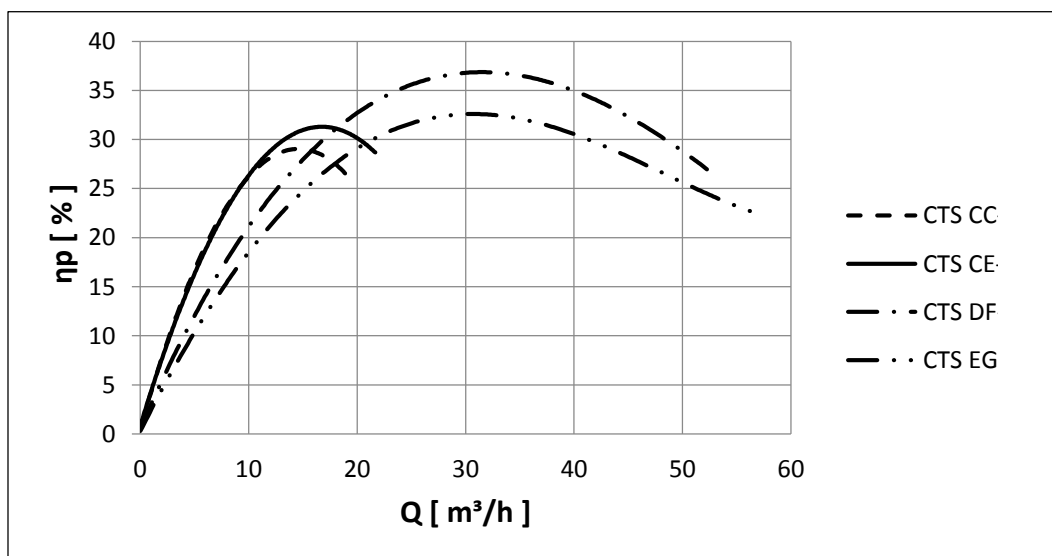
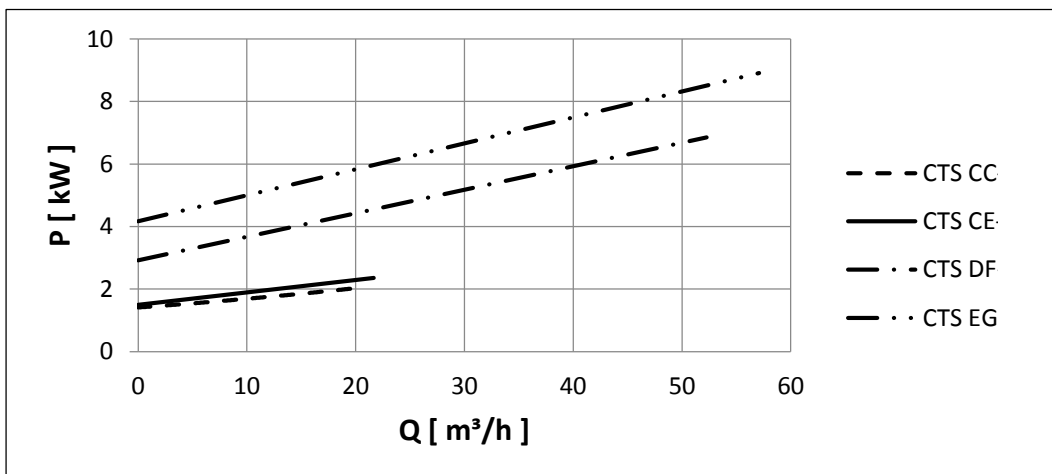
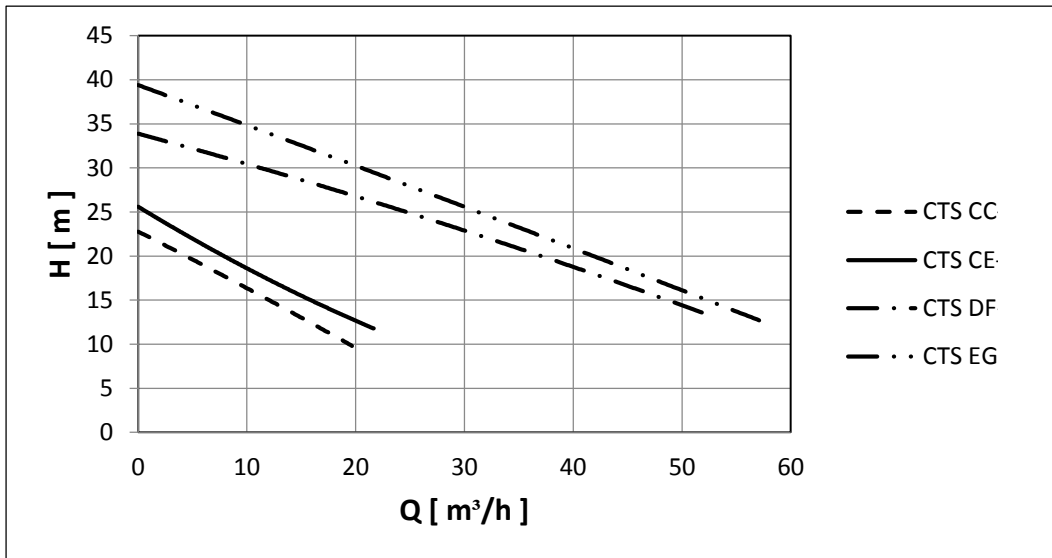

6. WARRANTY

6. WARRANTY

6.1. Returning parts

When returning parts to Tapflo please follow this procedure:

- Consult Tapflo for shipping instructions.
- Cleanse or neutralize and rinse the part/pump. Make sure the part/pump is completely empty from liquid.
- Pack the return articles carefully to prevent any damage during transportation.

Goods will not be accepted unless the above procedure has been complied with.

6.2. Warranty

Tapflo warrants products under conditions as stated below for a period of not more than 12 months from installation and not more than 24 months from date of manufacturing.

1. The following terms and conditions apply to the sale of machinery, components and related services and products, of Tapflo (hereinafter "the products").
2. Tapflo (the manufacturer) warrants that:
 - a. its products are free of defects in material, design and workmanship at the time of original purchase;
 - b. its products will function in accordance with Tapflo operative manuals; Tapflo does not guarantee that the product will meet the precise needs of the Customer, except for those purposes set out in any invitation to render documents or other documents specifically made available to Tapflo before entering into this agreement;
 - c. high quality materials are used in the construction of the pumps and that machining and assembly are carried out to the highest standards.

Except as expressly stated above, Tapflo makes no warranties, express or implied, concerning the products, including all warranties of fitness for a particular purpose.

3. This warranty shall not be applicable in circumstances other than defects in material, design, and workmanship. In particular warranty shall not cover the following:
 - a. Periodic checks, maintenance, repair and replacement of parts due to normal wear and tear (seals, O-rings, rubber items, bushings, etc.);
 - b. Damage to the product resulting from:
 - b.1. Tampering with, abuse or misuse, including but not limited to failure to use the product for its normal purposes as stated at the time of purchase or in accordance with Tapflo instructions for use and maintenance of the product, or the installation or improper ventilation or use of the product in a manner inconsistent with the technical or safety standard in force;

6. WARRANTY

- b.2. Repairs performed by non-skilled personnel or use of non-original Tapflo parts;
 - b.3. Accidents or any cause beyond the control of Tapflo. including but not limited to lightning. water. fire. earthquake. and public disturbances. etc.;
4. The warrantee shall cover the replacement or repairing of any parts. which is documented faulty due to construction or assembling. with new or repaired parts free of charges delivered by Tapflo. Parts subjected to normal tear and wear shall not be covered by the warranty. Tapflo shall decide as to whether the defective or faulty part shall be replaced or repaired.
 5. The warrantee of the products shall be valid for a period in accordance to the current law from the date of delivery. under the condition that notice of the alleged defect to the products or parts thereof be given to Tapflo in written within the mandatory term of 8 days from the discovery. Repair or replacement under the terms of this warranty shall not give a right to an extension to. or a new commencement of. the period of warranty.
 6. Repair or replacement under the terms of this warranty shall not give a right to an extension to, or a new commencement of, the period of warranty. Repair or replacement under the terms of this warranty may be fulfilled with functionally equivalent reconditioned units. Tapflo qualified personnel shall be solely entitled to carry out repair or replacement of faulty parts after careful examination of the pump. Replaced faulty parts or components will become the property of Tapflo.
 7. The products are built in accordance with standard CE normative and are tested (where applicable) by Tapflo. Approval and tests by other control authority are for the customer's account. The products shall not be considered defective in materials. design or workmanship if they need to be adapted. changed or adjusted to conform to national or local technical or safety standards in force in any country other than that for which the unit was originally designed and manufactured. This warranty shall not reimburse such adaptations. changes or adjustments. or attempt to do so. whether properly performed or not. nor any damage resulting from them. nor any adaptation. change or adjustments to upgrade the products from their normal purpose as described in the products operative manual without the prior written consent of Tapflo.
 8. Installation. including electric and other connections to utility mains according to Tapflo drawings. is for the cost and responsibility of the customer. unless otherwise agreed in writing.
 9. Tapflo will not be liable on any claim. whether in contract. tort. or otherwise. for any indirect. special. incidental. or consequential damages. caused to the customer or to third parties. including loss of profits. arising by any possible infringement of par. 3 above or by the customer or third parties being in the impossibility of using the products.

Steady the above. Tapflo liability to the customer or third parties from any claim. whether in contract. tort. or otherwise. shall be limited to the total amount paid by the customer for the product that caused the damages.

Sweden

Filaregatan 4 | S-442 34 Kungälv

Tel: +46 303 63390

Fax: +46 303 19916

E-mail addresses:

Commercial questions: sales@tapflo.com

Orders: order@tapflo.com

Tech support: support@tapflo.com

Tapflo products and services are available in 75 countries on 6 continents.

Tapflo is represented worldwide by own Tapflo Group Companies and carefully selected distributors assuring highest Tapflo service quality for our customers' convenience.

AUSTRALIA | AUSTRIA | AZERBAIJAN | BAHRAIN | BELARUS | BELGIUM | BOSNIA & HERZEGOVINA | BRAZIL | BULGARIA | CANADA | CHILE | CHINA | COLOMBIA | CROATIA | CZECH REPUBLIC | DENMARK | ECUADOR | EGYPT | ESTONIA | FINLAND | FRANCE | GREECE | GEORGIA | GERMANY | HONG-KONG | HUNGARY | ICELAND | INDIA | INDONESIA | IRAN | IRELAND | ISRAEL | ITALY | JAPAN | JORDAN | KAZAKHSTAN | KUWAIT | LATVIA | LIBYA | LITHUANIA | MACEDONIA | MALAYSIA | MEXICO | MONTENEGRO | MOROCCO | THE NETHERLANDS | NEW ZEALAND | NORWAY | POLAND | PORTUGAL | PHILIPPINES | QATAR | ROMANIA | RUSSIA | SAUDI ARABIA | SERBIA | SINGAPORE | SLOVAKIA | SLOVENIA | SOUTH AFRICA | SOUTH KOREA | SPAIN | SUDAN | SWEDEN | SWITZERLAND | SYRIA | TAIWAN | THAILAND | TURKEY | UKRAINE | UNITED ARAB EMIRATES | UNITED KINGDOM | USA | UZBEKISTAN | VIETNAM

Tapflo Group Companies

Austria

Tapflo Austria
Tel: +43 732 27292910
sales@tapflo.at

Azerbaijan

Tapflo Azerbaijan LLC
Tel: +994 502660799
sales@tapflo.az

Baltic States

Tapflo Latvia
Tel: +371 67472205
sales@tapflo.lv

Belarus

Tapflo Belarus
Tel: +375 17 3934609
sales@tapflo.by

Bulgaria

Tapflo EOOD
Tel: +359 (2) 974 18 54
office@tapflo.org

Canada

Tapflo Canada
Tel: +1 514 813 5754
canada@tapflo.com

Croatia

Tapflo GmbH
Tel: +385 91 4884 666
sales@tapflo.hr

Czech Republic

Tapflo s.r.o.
Tel: +420 513033924
tapflo@tapflo.cz

China

Tapflo (Wuxi)
Tel: +86 510 8241 7602
sales@tapflo.cn

Denmark

Tapflo Danmark
Tel: +45 36 454600
info@tapflo.dk

France

Tapflo France
Tel: +33 1 34 78 82 40
info@tapflo.fr

Georgia

Tapflo Georgia
Tel: +995 577 463010
sales@tapflo.ge

India

Tapflo Fluid Handling India
Pvt Ltd
Tel: +91 20 65000215
ad@tapflo.in

Ireland

Tapflo Ireland Ltd
Tel: +353 1 2011911
info@tapflo.ie

Italy

Tapflo Italia
Tel: +39 0362307698
info@tapfloitalia.com

Japan

Tapflo Japan K.K.
Tel: +81-3-6240-3510
tapflojp@tapflo.co.jp

Kazakhstan

Tapflo Kazakstan
Tel: +7 727 3278347
sales@tapflo.kz

Poland

Tapflo Sp. z o.o.
Tel: +48 58 530 42 00
info@tapflo.pl

Romania

S.C. Tapflo Rom. S.r.l.
Tel: +40 21 3451255
sales@tapflo.ro

Russia

Tapflo Company
Tel: +7 495 232 18 28
sales@tapflo.com.ru

Serbia

Tapflo d.o.o.
Tel: +381 21 44 58 08
sales@tapflo.rs

Slovakia

Tapflo s.r.o.
Tel: +421 911 137 883
tapflo@tapflo.sk

Slovenia

Tapflo GmbH
Tel: +386 68 613 474
sales@tapflo.hr

Spain

Tapflo Iberica
Tel: +34 91 8093182
avives@tapfloiberica.es

South Africa

Tapflo (Pty) Ltd
Tel: +27 31 701 5255
sales@tapflo.co.za

Turkey

Tapflo Makina Ltd
Tel: +90 216 467 33 11
sales@tapflo.com.tr

Ukraine

TOB Tapflo
Tel: +380 44 222 68 44
sales@tapflo.com.ua

Uzbekistan

Tapflo Uzbekistan
Tel: +998 712340940
sales@tapflo.uz

United Kingdom

Tapflo (UK) Ltd
Tel: +44 2380 252325
sales@tapflo pumps.co.uk